

STM60280P15

6 STRING MODULAR COMBINER BOX PV FUSE 15A SWITCH 80A + SURGE PROTECTOR II UN 220VDC

Code	029STM60280P15
EAN	8430892319133

Combiner box technical data

Voltage	220 V DC
Surge protector	Tipo II
Incoming current rating	1x80A
No. of strings per tracker	6
Number of MPPT trackers	1
Fuse current	15 A
Maximum voltage (Uoc max)	220 V
Surge protector code	1 x PST140-220D
Surge protector type	II
Nominal discharge current (In)	20 kA
Maximum discharge current (Imax)	40 kA
Protection level at In (Up)	900 V
Ingress protection IP	IP65 - IEC 60529
Impact protection IK	IK08 - IEC 62262
Standards	IEC EN 6143-1/2

Dimensions

Product height	436 mm
Product width	418 mm
Product length	148 mm

Logistic data

Customs code	85371098
--------------	----------

Connection

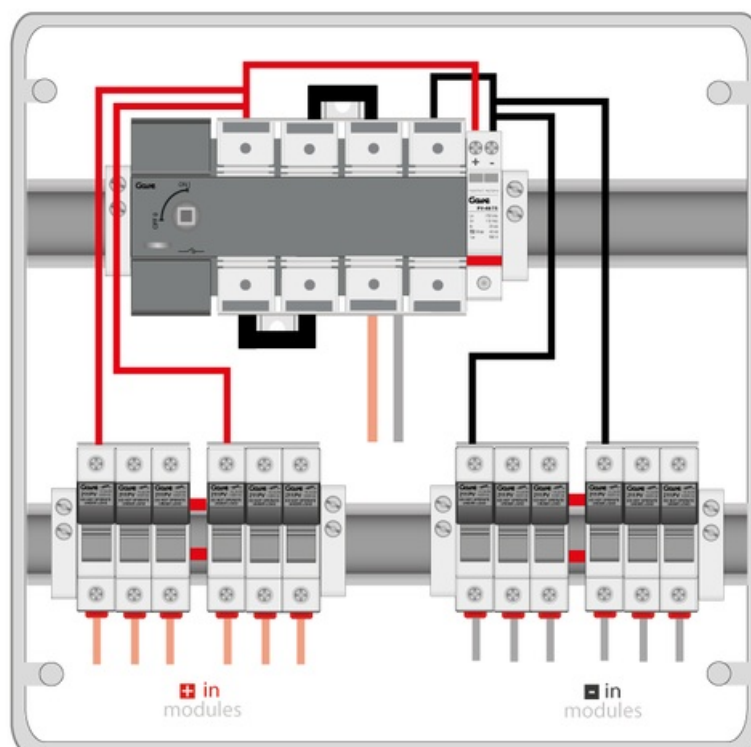

Dimensions

